





Watch Fibo-Trespo at TV :)  
"Sinnasnekker'n" TVN

## CONTENT

Crescendo .....	<b>NYHET</b>	page 04
Marcato .....	<b>NYHET</b>	page 11
White on White.....		page 26
Fortissimo .....		page 31
Ekstra lange panel .....		page 46
Colour Colection .....	<b>NYHET</b>	page 48
Legato .....		page 68
Adagio .....		page 69
Teknisk info .....		page 71
Tilbehør .....		page 71
Montering .....		page 72

## NOW WITH EXTRA TALL PANELS!

page 46- 47

3091 F08 HG Denver White

3091 L08 HG Denver White



2898 RU M63 Shabby Chic and 2069 S ME88 Zink

# WALLPANEL

The world of maintenance-free waterproof wall panels from Fibro-Trespo AS

Design your bathroms walls with high quality wallpanel from Fibro-Trespo AS. The panels are approved according to Norwegian plumbing directory and makes the work involving plaster, membrane and tiles redundant.

Laminate are pressed and hardened onto the panel and forms a watherproof surface. The panel are then milled with a 1.8 or 3.2 mm "groove" which gives the impression of tile. We also deliver panel without milling.

Combine our differendt collections of panels to suite your style.

The panels are large; 600 cm x 2400 mm. Follow the fitting instruction and you are guaranteed a great result that will last.



The panels may be mounted directly on the stud or on existing walls. The smooth and strong surface can withstand both direct water and large temperature fluctuations, is easy to clean and low maintenance. All panels are delivered with the unique Aqua Lock system.

We have divided our collection into 6 groups by design and appearance and named them: Marcato, Fortissimo, Crescendo, Legato, Adagio and Colour collection.



1534 Crescendo Sand Grande



1534 Crescendo Sand Grande



1534 Crescendo Sand Grande



# CRES

.. new  
bathro  
in a w



1532 Crescendo Negro Grande and 1533 Crescendo Gris Grande

# CENDO

*gorgeous  
room walls  
weekend*



1532 Crescendo Negro Grande and 1533 Crescendo Gris Grande



1531 Crescendo Blanco Grande



## CRESCENDO GRANDE

Tile pattern 600 x 300 mm

Crescendo's exclusive surface with pattern and design matched in perfect 3D.

Delivered in further 4 exclusive contemporary design with large tile pattern.



1534 Sand Grande



1534 Sand Grande



1531 Blanco Grande



1531  
Blanco Grande



1534  
Sand Grande



1533  
Gris Grande



1532  
Negro Grande



## CRESCENDO CASABLANCA

Tile pattern 200 x 300 mm

Crescendo collection consists of wall panels with 3D tiling. There is a height- and surface difference between the tiles.

When fitting Crescendo check alignment of border prior to final fitting.



1525 Casablanca Azurro



1528 Casablanca Artico



1525 Casablanca Azurro - blue



1526 Casablanca Grigio - grey/brown



1528 Casablanca Artico - light grey





# MARCATO

Marcato collection comes in a variety of colors, surfaces and tile sizes.

Joint width can be white or grey

The wallpanel having the same color and joint width can be used in combination with each other.



0194 Marina Grey Oak M6040 and 3091 Denver White M6040

# DECOR WALLPANEL MARCATO

Joint width 1,8 mm

white fugue

Grey fugue

## Design M00 No tile pattern



## Design M10 Milled right side

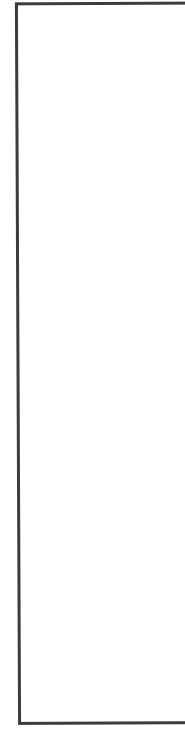

## Design M6015

Tile pattern 600x150 mm

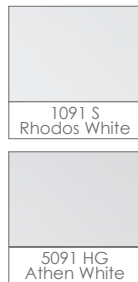

## Design M63 / M6030

Tile pattern 600 x 300 mm

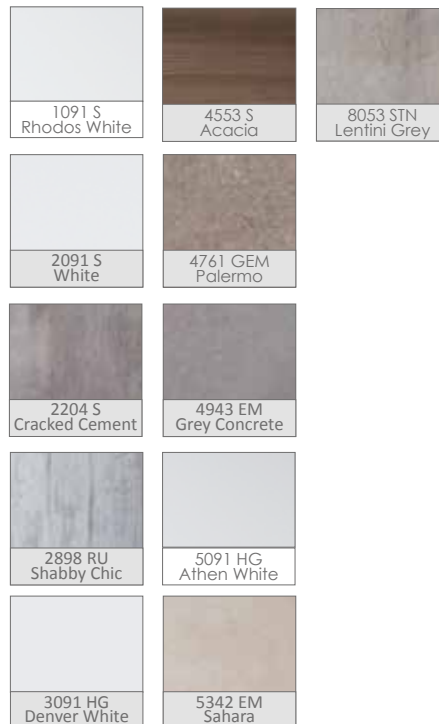
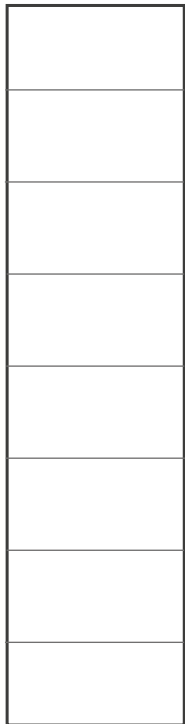

## Design ME88

Decorative panel; 300 mm



Note: the colors may differ slightly from the actual product. Abbreviations: HG = High Gloss, G = Gloss, S = Silk, SL = Slate, FW = Fresh Wood (rough surface) EM = Extra Matt, RU = Rustic, SA = Spatalatto, SC = Saw cut, C = Cement, P1 = Matt surface with high gloss pattern.

### Design M0303

Tile pattern 30x30 mm

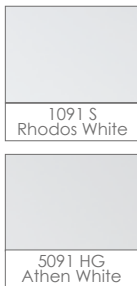
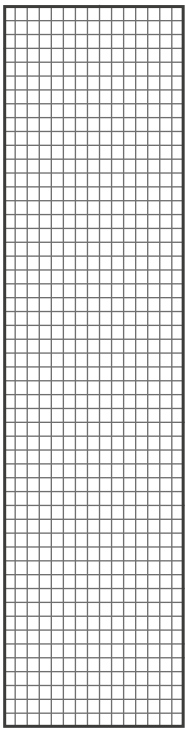

### Design M2007

Tile pattern 200xca.70 mm

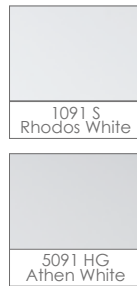
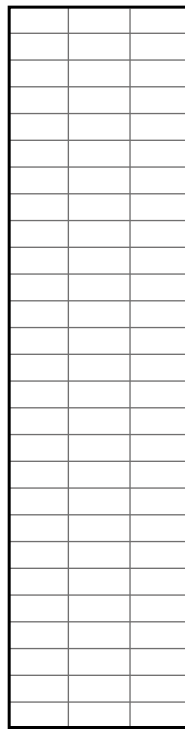

### Design M3005

Tile pattern 300x50 mm

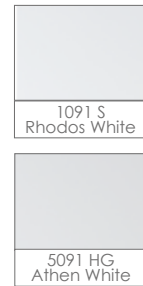
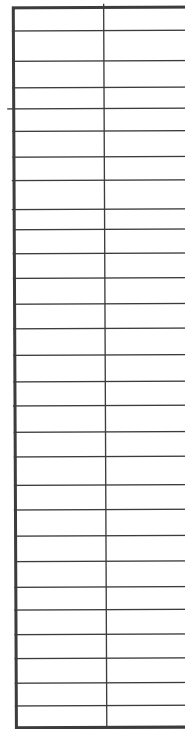

### Design M6020

Tile pattern 600x200 mm



### Design M6040

Tile pattern 600x400 mm



### Design M66 / M6060

Tile pattern 600 x 600 mm

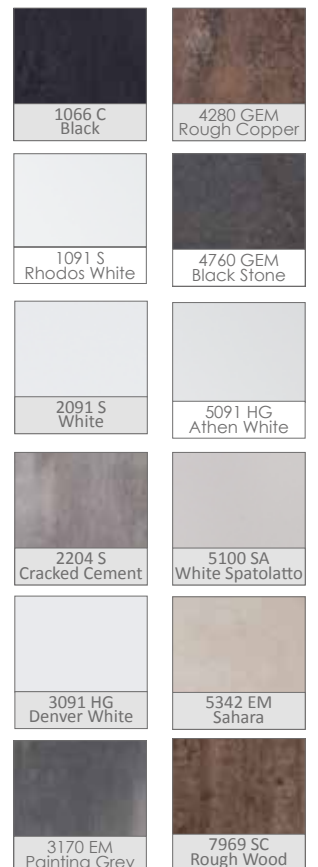
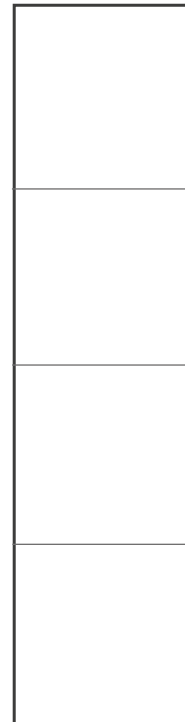



# MARCATO DESIGN Moo

No tile pattern



1066 C  
Black



2204 S  
Cracked Cement



2898 RU  
Shabby Chic



4943 EM  
Grey Concrete



5100 SA  
White Spatolato

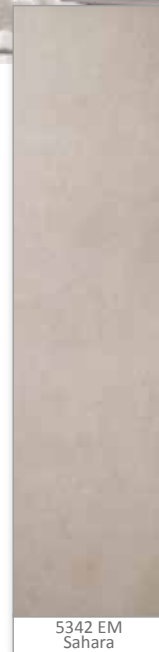

5342 EM  
Sahara



3170 EM  
Painting Grey



4280 GEM  
Rough Copper



4553 S  
Acacia



4618 HG  
Grand Piano



4761 GEM  
Palermo



7969 SC  
Rough Wood



8053 STNC  
Lentini Grey



# MARCATO DESIGN Moo

No tile pattern

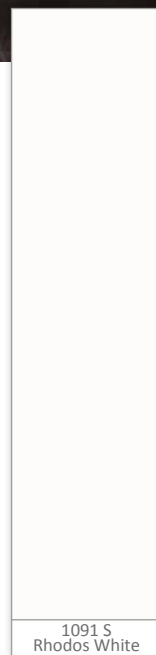



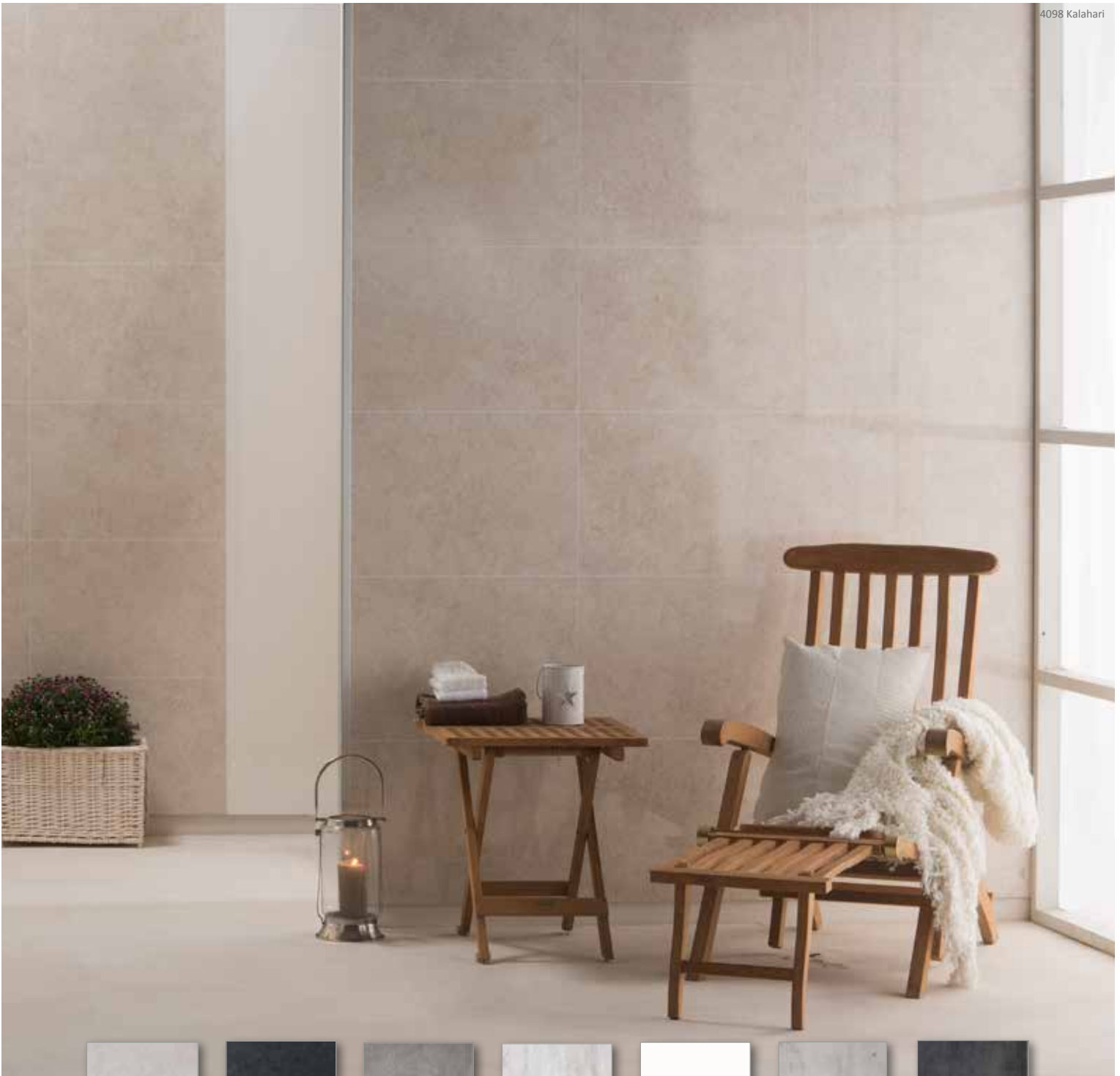

4098 HG  
Kalahari



4760 GEM  
Black Stone



4746 STN  
Grey Sahara



4281 EM  
Abbey Shale

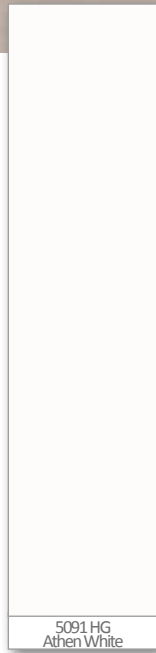

5091 HG  
Athen White



8054 STN  
Lentini Light



8056 STN  
Lentini Dark



## MARCATO DESIGN M63/M6030

Tile pattern 600 x 300 mm

Marcato M63 with large tiles give a fashionable look to your walls.

Enjoy the special surface and abience these panels provide.



2091 S  
White

2204 S  
Cracked Cement

2898 RU  
Shabby Chic

3091 HG  
Denver White

4553 S  
Acacia

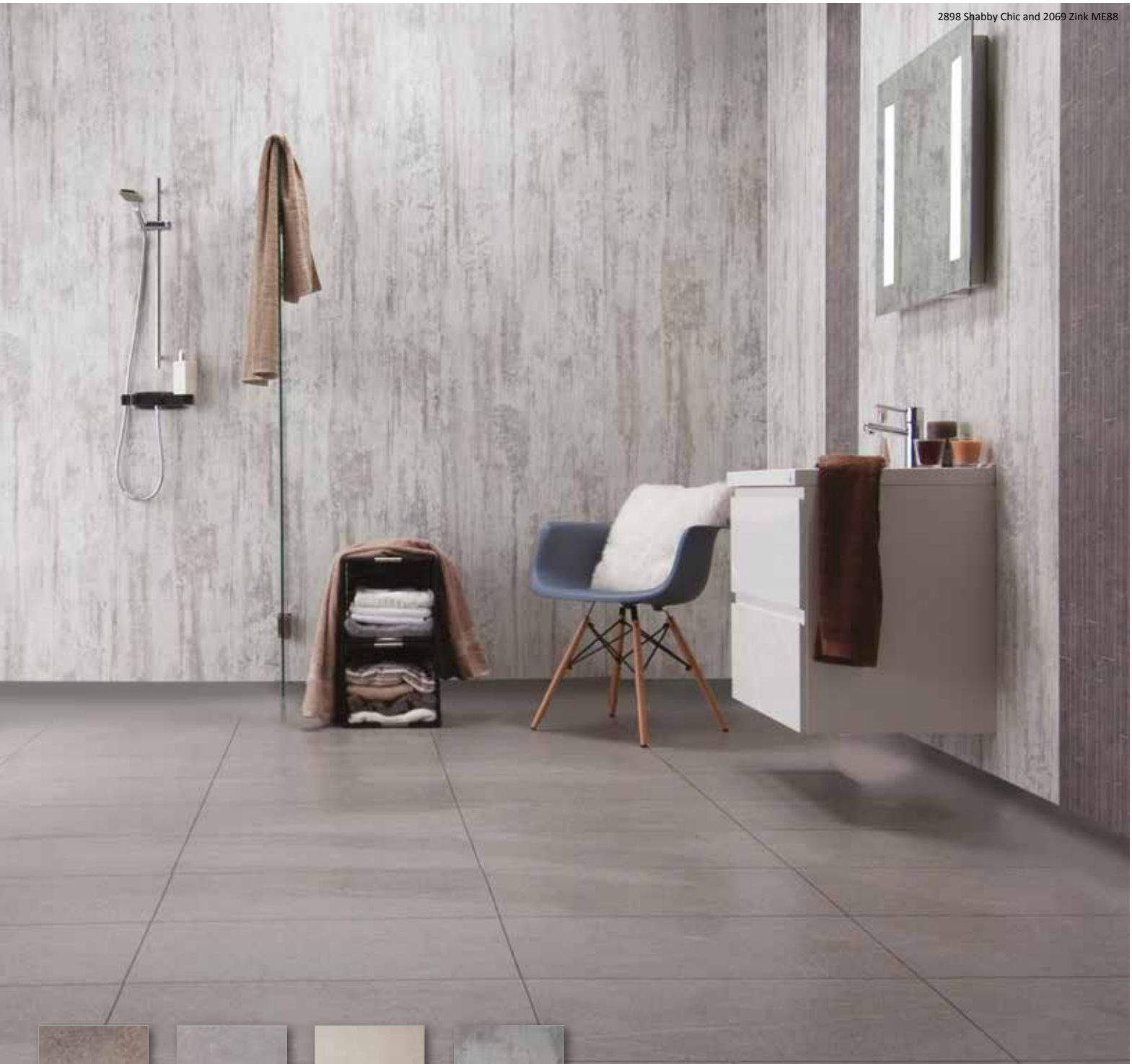

4761 GEM  
Palermo



4943 EM  
Grey Concrete



5342 EM  
Sahara

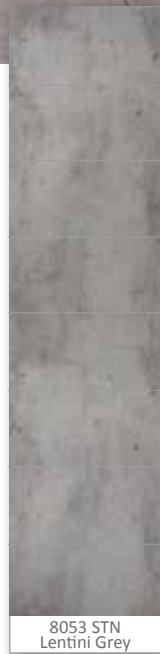

8053 STN  
Lentini Grey



8054 STN Lentini Light M6040



8056 STN Lentini Dark M6040



## MARCATO DESIGN M6040

Tile pattern 600 x 400 mm  
Between large surfaces and sleek designs. This shows decors where joint width is 1.8 mm, and groove color is white.

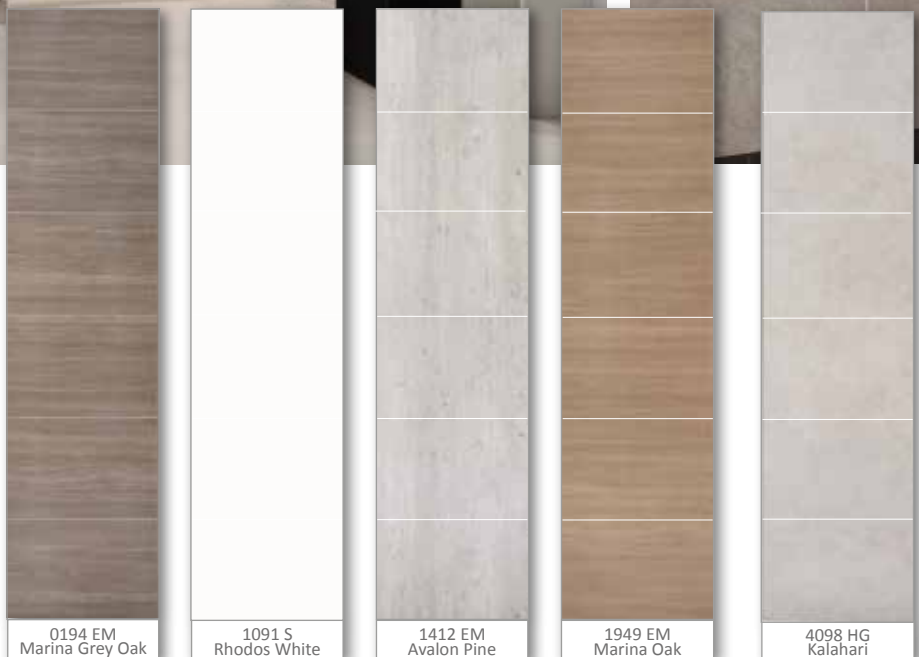

0194 EM  
Marina Grey Oak

1091 S  
Rhodos White

1412 EM  
Avalon Pine

1949 EM  
Marina Oak

4098 HG  
Kalahari



4746 STN  
Grey Sahara



4281 EM  
Abbey Shale



5091 HG  
Athen White



8054 STN  
Lentini Light



8056 STN  
Lentini Dark





## MARCATO DESIGN M66/M6060

Tile pattern 600 x 600 mm  
Large expanses and stunning design.

With 1.8mm groove, colour grey



1066 C  
Black

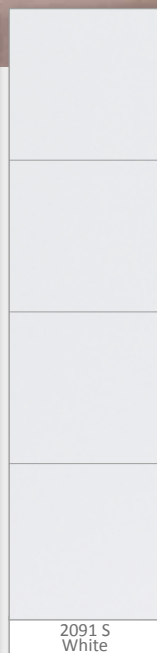

2091 S  
White



2204 S  
Cracked Cement

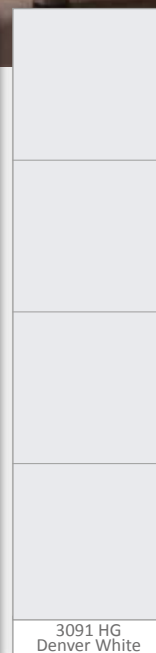

3091 HG  
Denver White

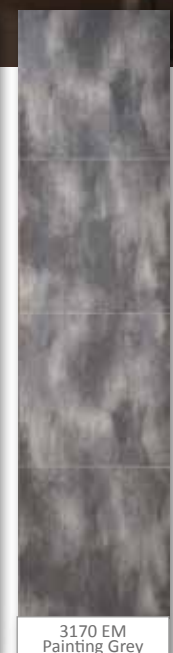

3170 EM  
Painting Grey



4280 GEM  
Rough Copper

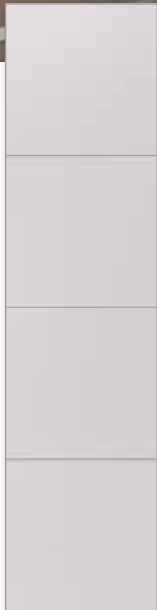

5100 SA  
White Spatolato

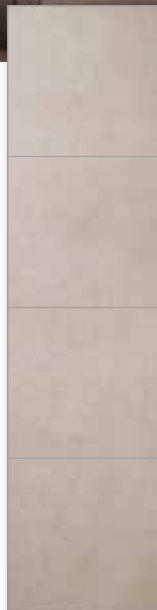

5342 EM  
Sahara



7969 SC  
Rough Wood





## MARCATO DESIGN M66/M6060

Tile pattern 600 x 600 mm  
Large expanses and stunning design.

With 1.8mm groove, colour white.

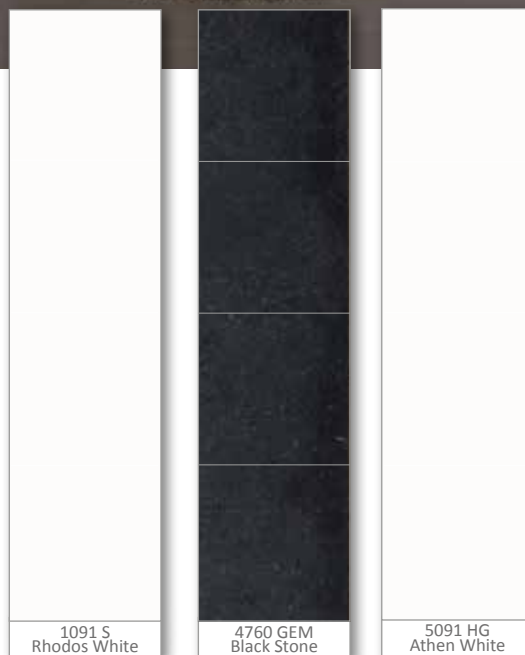





## MARCATO DESIGN ME88

Decorative panel 30 cm wide

Special design intended for use between other design to give an elegant touch to your bathroom.



1066 C  
Black



2069 S  
Zink



4091 SL  
White  
Slate

# MARCATO ATHEN WHITE OG RHODOS WHITE

Our white decors in the Marcato collection comes in a large selection of tile sizes. In addition to those presented in the preceding pages, we have tile sizes who are presented below. They all have 1.8mm white groove.



Marcato collection contains white panels with white grout. The collection consists of two surfaces; 1091 Rhodes White silk surface and 5091 Athens White high gloss finish.

Both surfaces coming with 10 different tile sizes from 600x2400mm to 30x30mm.

Do not let the thought of cleaning the white grout haunt you - we have the best solution for you!

The design and easy maintenance of our panels will keep the joints white for years to come.

Design M10  
Milled right side

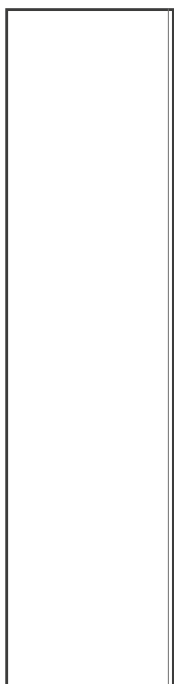

Design M0303  
Tile pattern  
30 x 30 mm

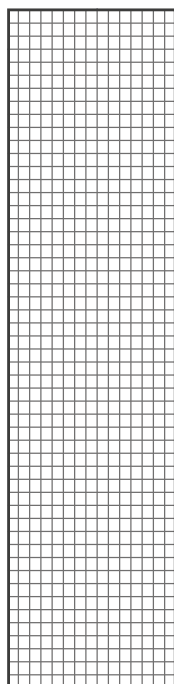

Design M2007  
Tile pattern  
200 x 70mm

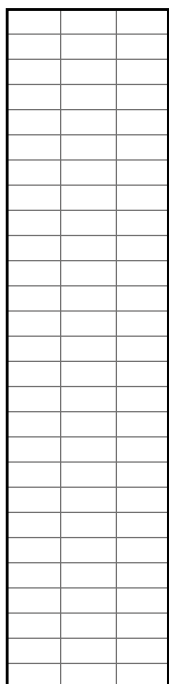

Design M3005  
Tile pattern  
300 x 50 mm

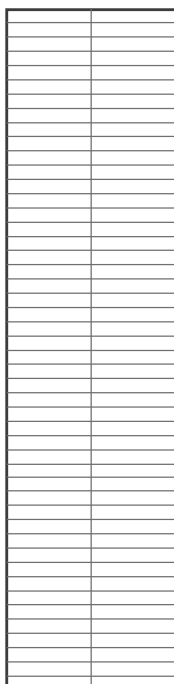

Design M6015  
Tile pattern  
600 x 150 mm



Design M6020  
Tile pattern  
600 x 200 mm



Design M6030  
Tile pattern  
600 x 300 mm

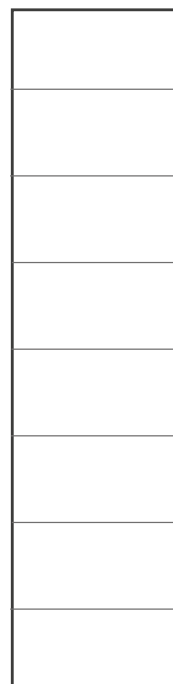

Note: the colors may differ slightly from the actual product.  
Abbreviations: HG = High Gloss, SL = Slate, EM = Extra Matt, RU = Rustic, SA = Spatolato, C = Cement



1091 S Rhodos White M2007andg 4063 HG Oslo F00



1091 S Rhodos White M0303 and 2212 HG Aquamarine F00



1091 S Rhodos White M0303 and M6020



5091 HG Athen White M0303 and 4149 HG Beach F00



Note: the colors may differ slightly from the actual product.  
Abbreviations: HG = High Gloss, SL = Slate, EM = Extra Matt, RU = Rustic, SA = Spatolato, C = Cement



gorgeous white joints for all!





3091 HG F01 Denver White



# FORTISSIMO

Fortissimo-collection comes in a variety of colors, surfaces and milling pattern. Laminate are pressed and hardened onto the panel and forms a watherproof surface. The panel are milled with a 3.2 mm "groove" which gives the impression of tile.

The majority of Fortissimo panels have the same tile groove, color and size, between the tiles and can therefore be combined just as you like. The exception is 2520 Ivory F23, 2586 Santiago F22 and 2506 Toscana F23 who have a narrower gap between the "tiles" than the rest of the Fortissimo range.

Forkortelser:

HG = High Gloss

G = Gloss, S = Silk

SL = Slate

FW = Fresh Wood (rough surface)

PI = Matt surface with high gloss pattern



# DECOR WALLPANEL FORTISSIMO

3,5 mm joint width, groove colour grey

## Design F00

No tile pattern

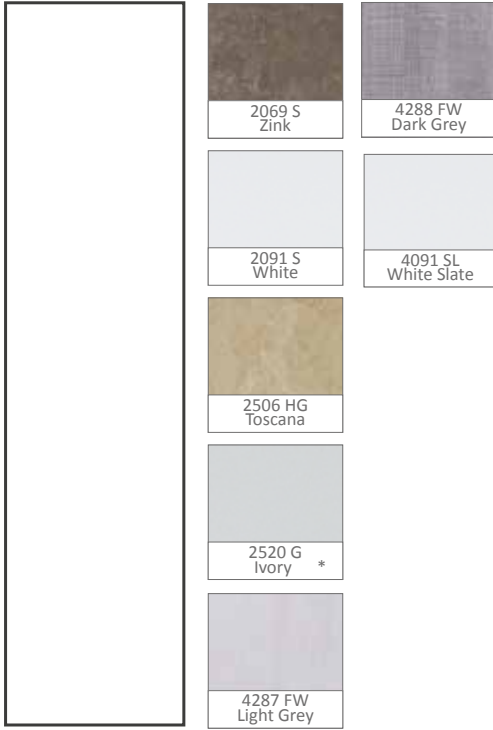

## Design F01

Tile Pattern 600 x 400 mm

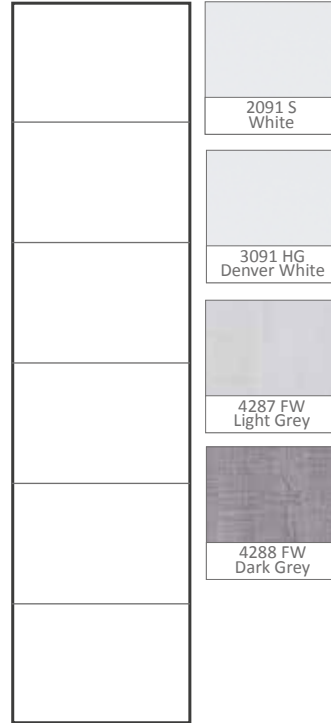

## Design F03

Tile Pattern 300 x 50 mm

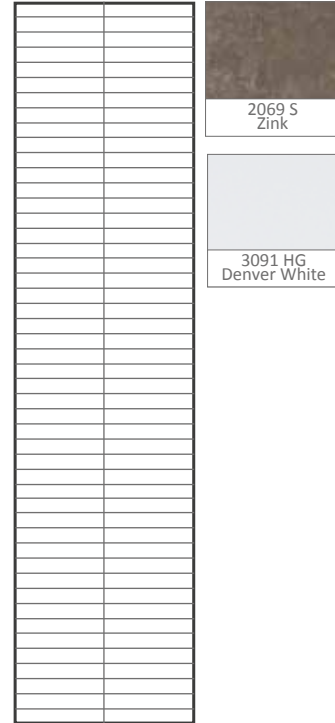

Note: the colors may differ slightly from the actual product.

Abbreviations: HG = High Gloss, G = Gloss, S = Silk, SL = Slate, FW = Fresh Wood (rough surface)

EM = Extra Matt, RU = Rustic, SA = Spatolato, SC = Saw cut, C = Cement, P1 = Matt surface with high gloss pattern.

\* = Tile pattern included in the Colour Collection - info: page 48 - 65

## Design F24

Tile pattern 600 x 150 mm

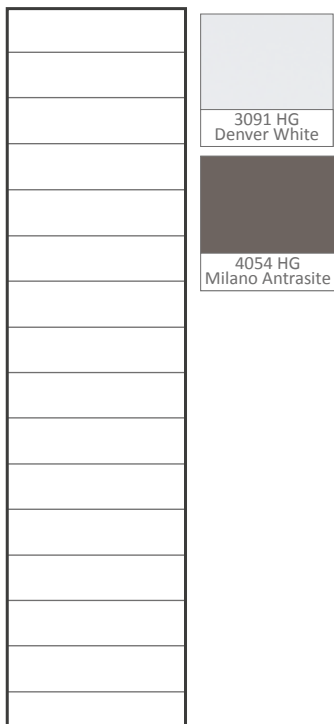

## Design F25

Tile pattern 150 x 150 mm

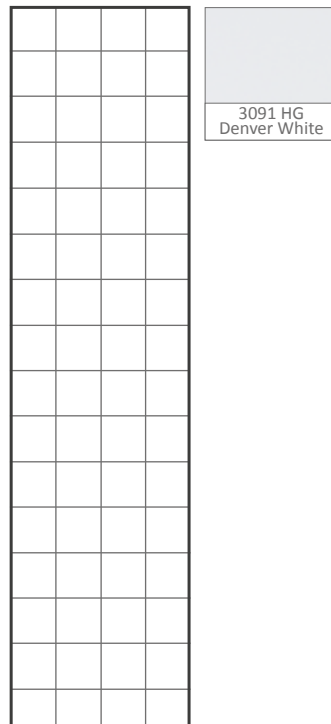

## Flower

No tile pattern 600 x 2400 mm

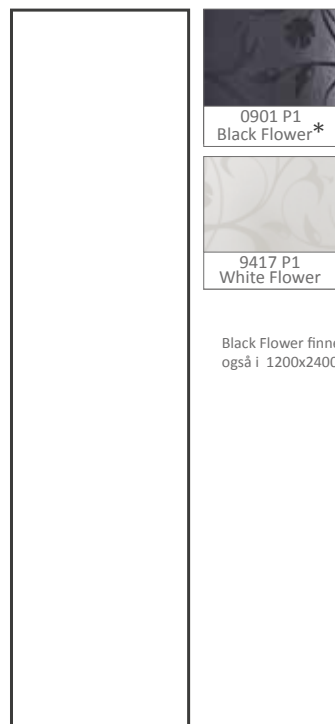

Black Flower finnes også i 1200x2400 mm.



### Design F05

Tile pattern 600 x 200 mm

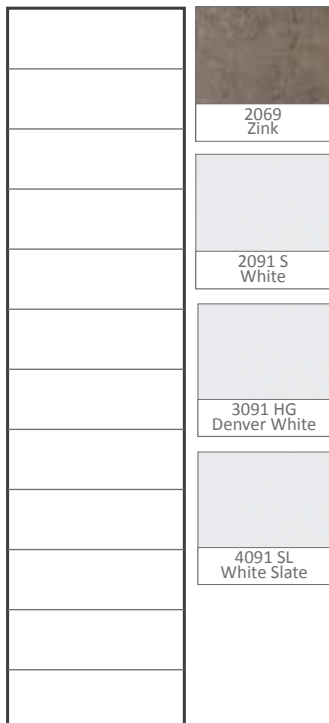

### Design F08

Tile pattern 150 x 200 mm

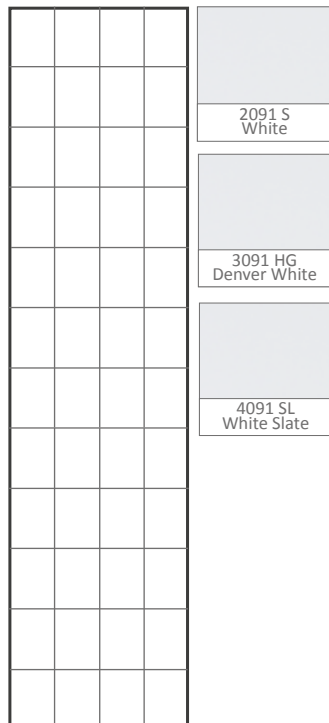

### Design F22

Tile pattern 300 x 400 mm

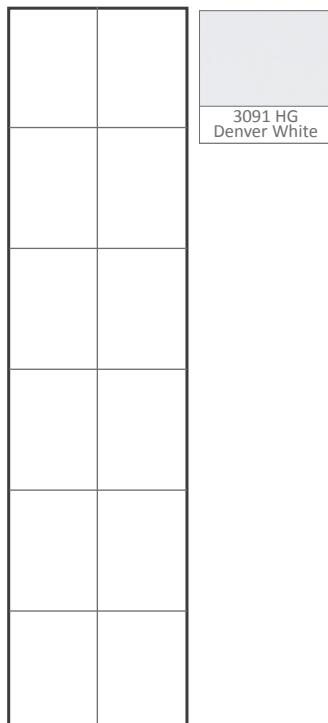

### Design F23

Tile pattern 200 x 300 mm

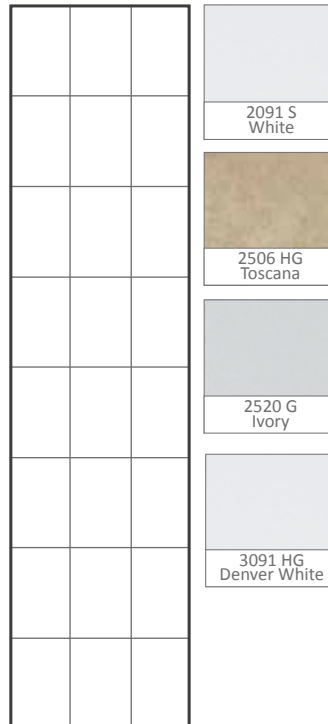

2520 G F23 Ivory



2520 G F23 Ivory



4943 EM M63 Grey Concrete and 2091 S M66 White

## FORTISSIMO DESIGN Foo

No tile pattern

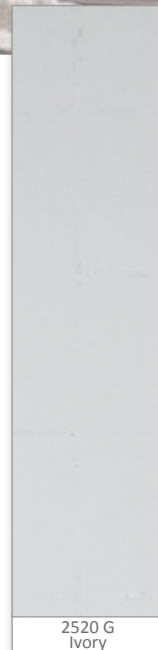
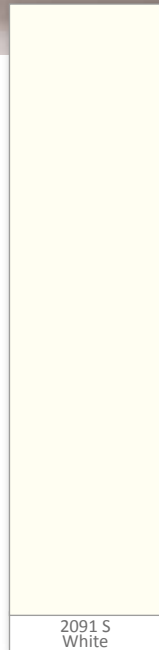



4280 Rough Copper M 6060 and 1091 Rhodos White M 6030



4287 FW  
Light Grey



4288 FW  
Dark Grey

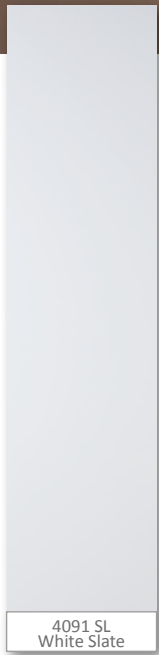

4091 SL  
White Slate



2091 S F01 White and 4288 FW F01 Dark Grey

**GUARANTEED  
WATERPROOF  
- EVEN IN THE  
SHOWER**

## **FORTISSIMO DESIGN F01**

Design F01; wall panel with a large tile pattern.

The pattern is 600 x 400 mm and a great combination with other design.





3290 SL F01 Dark Slate and 3091 HG F03 Denver White



2069 S  
Zink

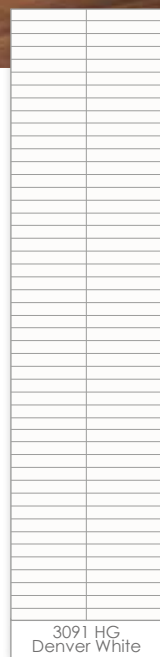

3091 HG  
Denver White

## FORTISSIMO DESIGN F03

Wall Panel with tile pattern 300 x 50 mm  
in classic and bright colors.

Combine different colors and tile size and  
create something unique. A pleasure to use  
such a bathroom every morning.





4091 SL F05 White Slate

## FORTISSIMO DESIGN F05

Wallpanel with tile pattern  
600 x 200 mm for a classic  
and beautiful bathroom.

You may combine and design your  
room exactly the way you prefer.  
The possibilities are endless.

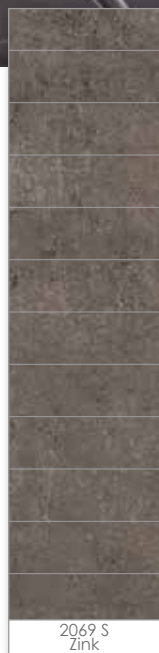

2069 S  
Zink



2091 S  
White



3091 HG  
Denver White



4091 SL  
White Slate



3091 HG F05 og F08 Denver White

## FORTISSIMO DESIGN F08

Wallpanel with tile pattern 150 x 200 mm.

Design F08 has the classic size and decor,  
that all recognize and enjoy.

Choose between three different surfaces.

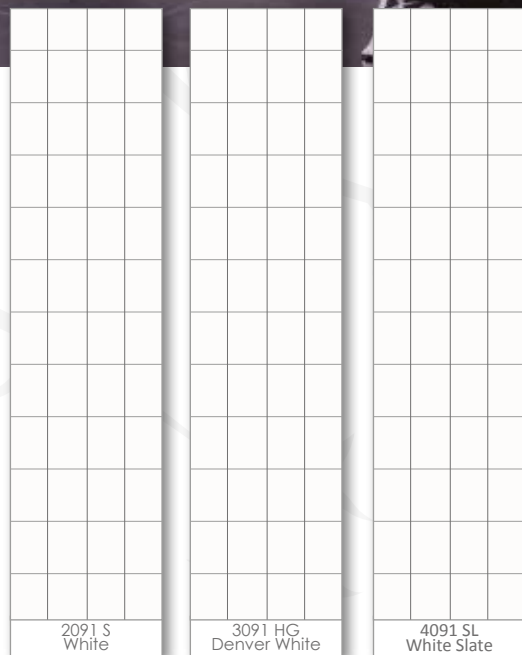



## FORTISSIMO DESIGN F22

Tile pattern 300 x 400 mm

With our simple installation, you can renew your bathroom walls in a weekend!

The majority of Fortissimo panels have the same tile groove, colour and size, between the tiles and can therefore be combined just as you like. the exception is 2520 Ivory F23, 2586 Santiago F22 and 2506 Toscana F23 who have a narrower gap between the "tiles" than the rest of the Fortissimo range.









## FORTISSIMO DESIGN F24

Tile pattern 600 x 150 mm

Big or small; Fibo-Trespo Wall Panels provides freedom of choice, to your bathroom, at an affordable price.

Wall Panel Design F24 and F25 classic and beautiful. Combine these designs or one design in the entire bathroom.

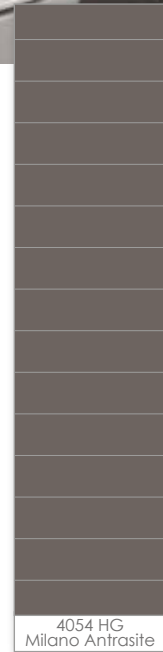



4054 HG F03 and F24 Milano Antrasite and 3091 HG F30 Denver White

## FORTISSIMO DESIGN F25

Tile pattern 150 x 150 mm

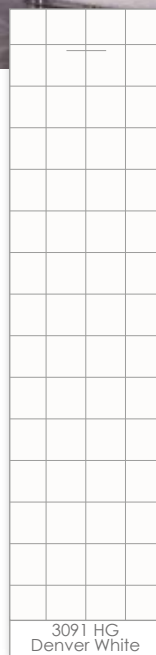

3091 HG  
Denver White



3091 HG F25 Denver White



## BLACK & WHITE FLOWER

Wallpanel no tile pattern, 600 x 2400 mm

The panels are best suited as decorative panels, then the pattern is not reports. Black Flower also comes to 1200 mm width, and can easily be combined with other Fibo-Trespo Wall Panel decors.

Lighting determines how prominent the delicate flowers pattern becomes. The pattern is tone-on-tone matt / gloss- a right exclusive choices.



9417 P1  
White Flower



0901 P1  
Black Flower





3091 HG L00  
Denver White  
11x620x3020mm

2091 S L00  
White  
11x620x3020mm

## HIGH CEILING?

For special ceiling heights and a dramatic effect, we have our long panels at 3020 mm.

The current building styles with new ceiling heights require more of products and developer. As the only manufacturer Fibro-Trespo now supply panels at the height of 3020 mm.



3091 HG L01  
Denver White



2091 S L01  
White

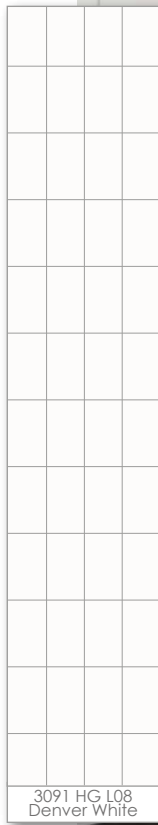

3091 HG L08  
Denver White



2091 S L08  
White



2091 S White L23



3091 HG L24  
Denver White



4054 HG L24  
Milano Antrasite



3091 HG L23  
Denver White



2091 S L23  
White



3091 HG L23 Denver White and 4054 HG L24 Milano Antrasite

2101 HG Red Tile F03 and 3091 HG White Tile F24



0529 Havana M00 and M6040 and 5091 HG Athen



0092 Marrakech M6040 and 1091 S Rhodos M6040



**COLOUR  
COLLECTION**

....What  
dream  
bath



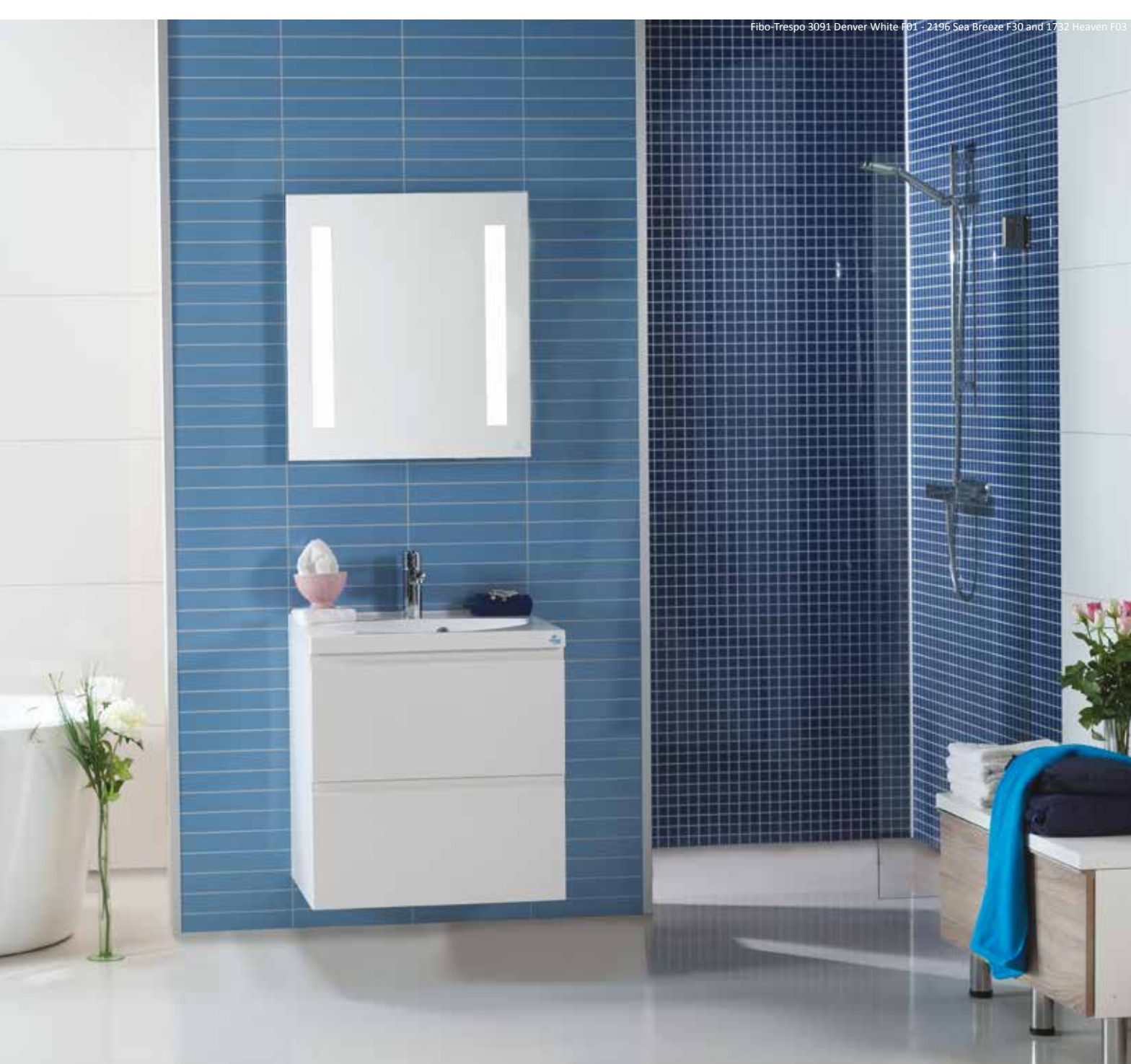

# OUR SECTION

What is your  
choice in the  
bathroom?



# COLOUR COLLECTION

## HIGH GLOSS FINISH 1,8 OG 3,5 MM JOINT WIDTH

For interior designers, architects and creative souls we supply Fibo-Trespo Colour Collection.

Wallpanel with bright, clear colors and a high gloss finish. If desired we deliver the panels with 8 different tile patterns. 3,5 mm groove.

Note: the colors may differ slightly from the actual product.



Colour Collection wallpanel with **1,8mm joint width** and groove colour **grey**, comes in high gloss finish.

Design M00 Fuge på høyre side	Design M10 Fuge på høyre side	Design M0303 Flisstørrelse 3x3cm	Design M3005 Flisstørrelse 30x5cm	Design M6015 Flisstørrelse 60x15cm	Design M6020 Flisstørrelse 60x20cm	Design M6030 Flisstørrelse 60x30cm	Design M6040 Flisstørrelse 60x40cm	Design M6060 Flisstørrelse 60x60cm

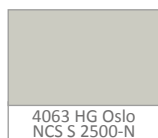
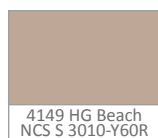
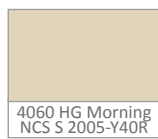
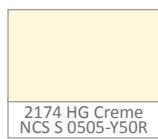
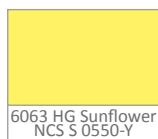
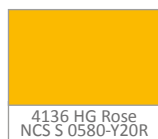
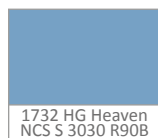
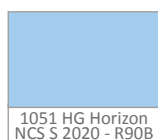
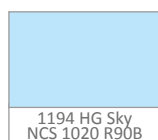
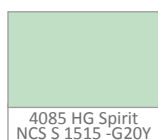

## Colour Collection with 3,5 mm groove colour.



Colour Collection is delivered in various tile patterns:

Design F00	No tile pattern
Design F01	Tile pattern: 600 x 400 mm
Design F03	Tile pattern: 300 x 50 mm
Design F05	Tile pattern: 600 x 200 mm
Design F08	Tile pattern: 150 x 200 mm
Design F10	Milled right edge
Design F23	Tile pattern: 200 x 300 mm
Design F24	Tile pattern: 600 x 150 mm
Design F30	Tile pattern: 30 x 30 mm

Fibo-Trespo Colour Collection is delivered in 2-pack.

Colour Collection wallpanel with **3,5mm joint width** and groove colour **grey**, comes in high gloss finish.

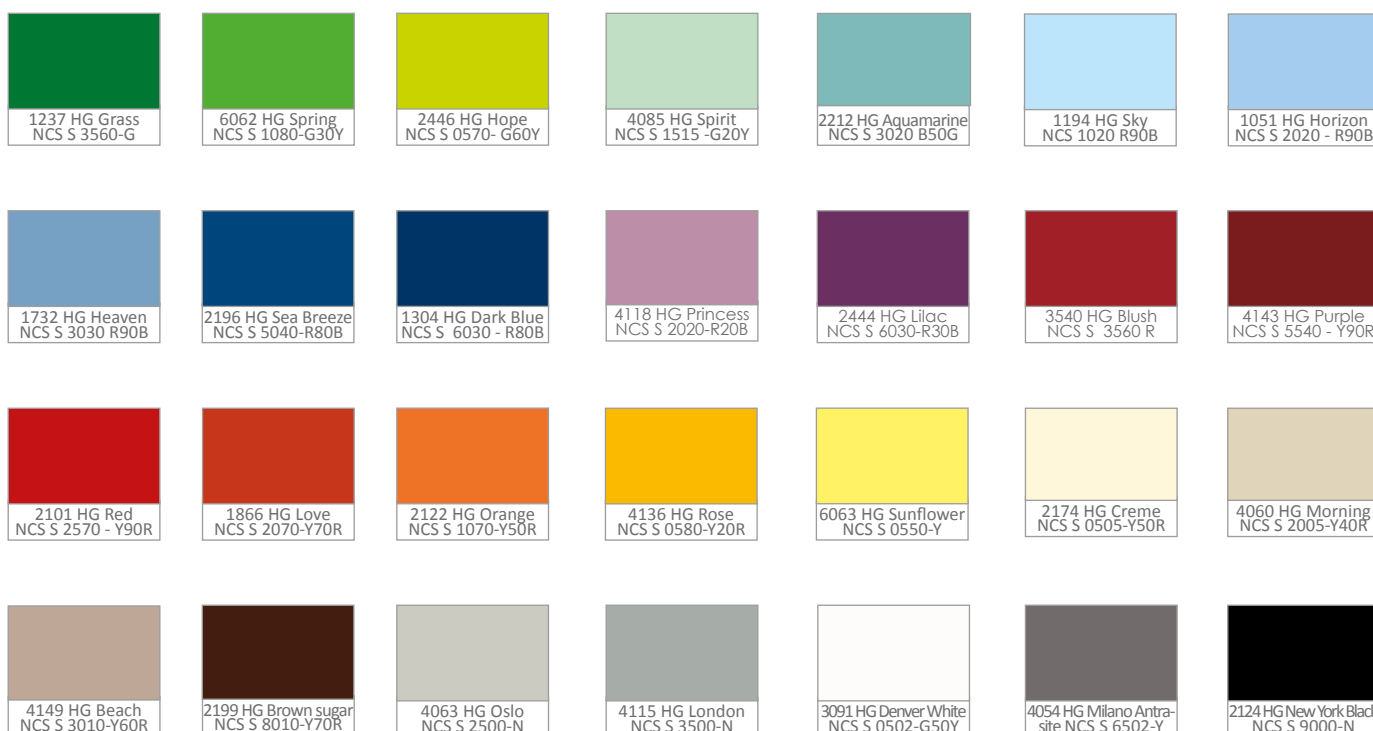
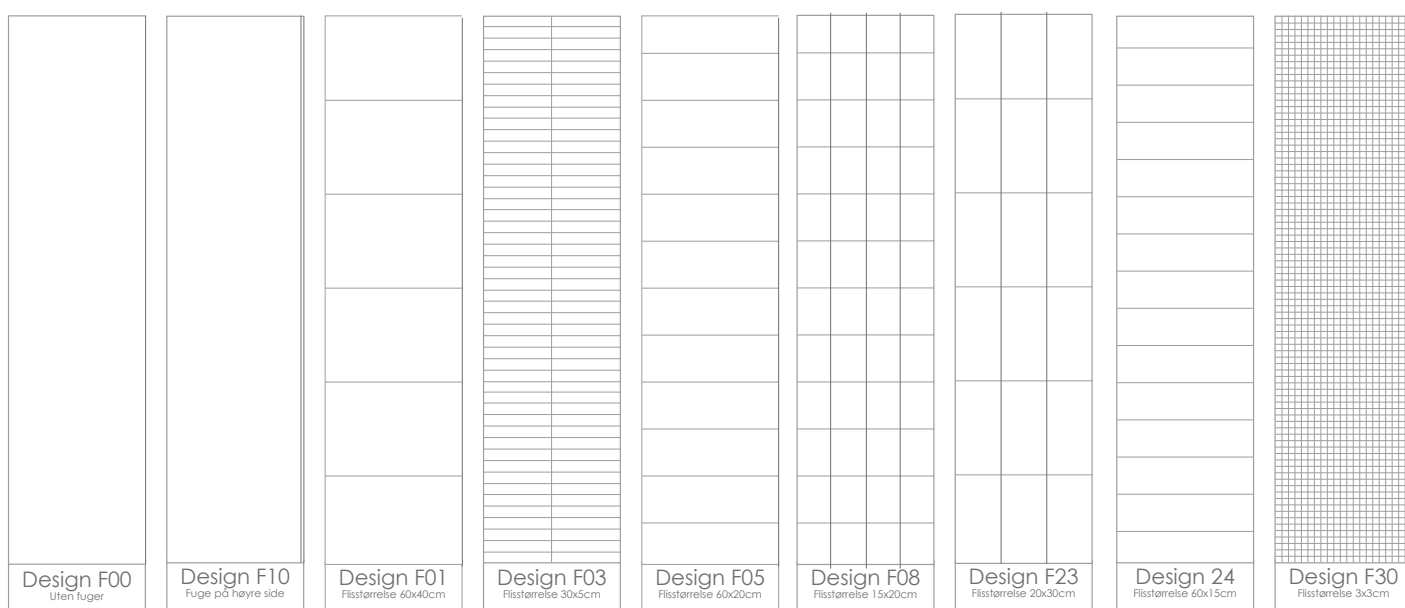

Note: the colors may differ slightly from the actual product. Abbreviations: HG = High Gloss, SL = Slate, EM = Extra Matt, RU = Rustic, SA = Spatolato, C = Cement

3091 HG F01 Denver White and 2212 HG F05 Aquamarine



## HEAVEN AND SEA

In the earlier days blue was an expensive color to produce. Only kings and very wealthy people could afford blue colored clothings or paint. Hence the term "royal blue". It was normal to be portrayed wearing blue even if you did not own any blue clothings.

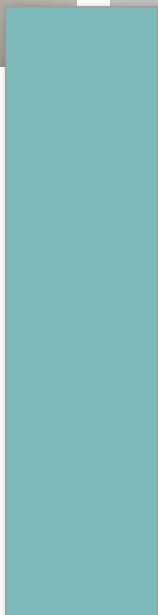

2212 HG Aquamarine  
NCS S 3020 B50G



1194 HG Sky  
NCS 1020 R90B

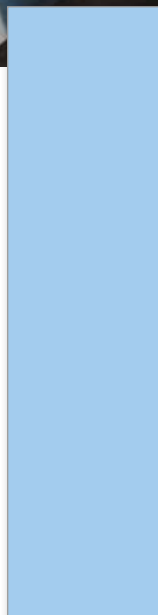

1051 HG Horizon  
NCS S 2020 - R90B



1732 HG Heaven  
NCS S 3030 R90B



2196 HG Sea Breeze  
NCS S 5040-R80B



1304 HG Dark Blue  
NCS S 6030 - R80B

3091 HG F01 Denver White and 6063 HG F00 Sunflower



6063 HG Sunflower



## WEALTH AND OPTIMISM

Yellow, in the form of yellow ochre pigment made from clay, was one of the first colors used in prehistoric cave art. The cave of Lascaux has an image of a horse colored with yellow estimated to be 17,300 years old.

Yellow is valued because of its high visibility. It has replaced red as the color of emergency vehicles, and is popular in neon signs, especially in Las Vegas and China.

Yellow is commonly associated with gold, wealth, sunshine, reason, happiness, optimism and pleasure, but also with envy, jealousy and betrayal.

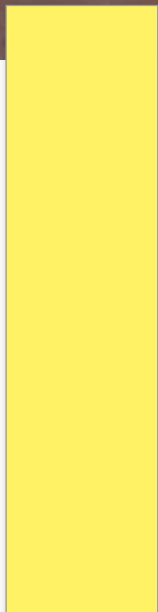

6063 HG Sunflower  
NCS S 0550-Y

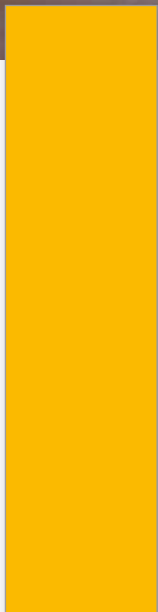

4136 HG Rose  
NCS S 0580-Y20R

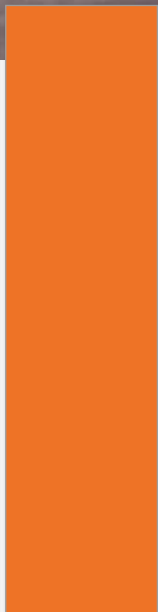

2122 HG Orange  
NCS S 1070-Y50R



1866 HG Love  
NCS S 2070-Y70R



2101 HG Red  
NCS S 2570 - Y90R



4118 HG Princess  
NCS S 2020-R20B



2444 HG Lilac  
NCS S 6030-R30B



3540 HG Blush  
NCS S 3560 R



4143 HG Purple  
NCS S 5540 - Y90R

## PURPLE

Purple was one of the first colors used in pre-historic art. They used sticks of manganese and hematite powder to draw and paint animals and the outlines of their own hands on the walls of their caves. These works have been dated to between 16,000 and 25,000 BC.

In 15th century BC the process of making the purple and red dye was long, difficult and expensive. Purple became the color of kings, nobles, priests and magistrates.

Purple and red colors have through the years been associated with extravagance and individualism. It is often used to attract attention.



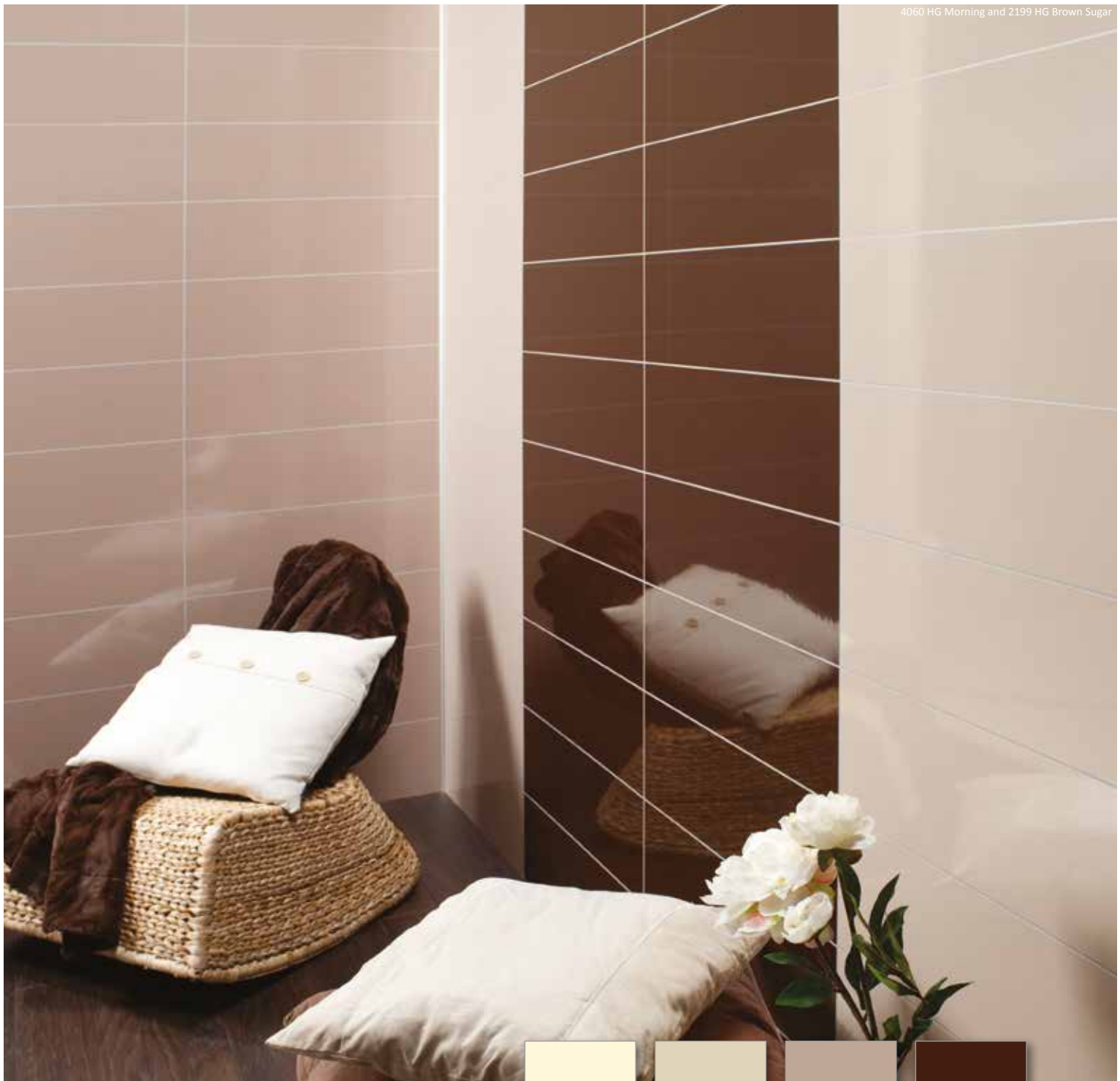

## SAND AND EARTH

The first recorded use of beige as a color name in English was in 1887. Beige ranging from bright to deep tones in a combination of yellow, red and brown.

The light beige tones providing tranquility and peace, the deeper tones contrasts we need, both in the interior and in life as such. The tones are associated with beaches, hot coffee, spices, and gives the interior an oriental touch.





4085 HG Spirit  
NCS S 1515 -G20Y

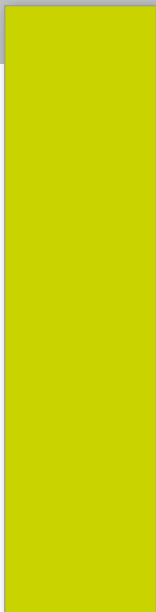

2446 HG Hope  
NCS S 0570- G60Y



6062 HG Spring  
NCS S 1080-G30Y



1237 HG Grass  
NCS S 3560-G

## GRASS AND NATURE

The modern English word green comes from the Middle English and Anglo-Saxon word grene, from the same Germanic root as the words "grass" and "grow".

Green colors are most commonly associated with nature, youth, spring, hope, envy and a symbol of fertility.

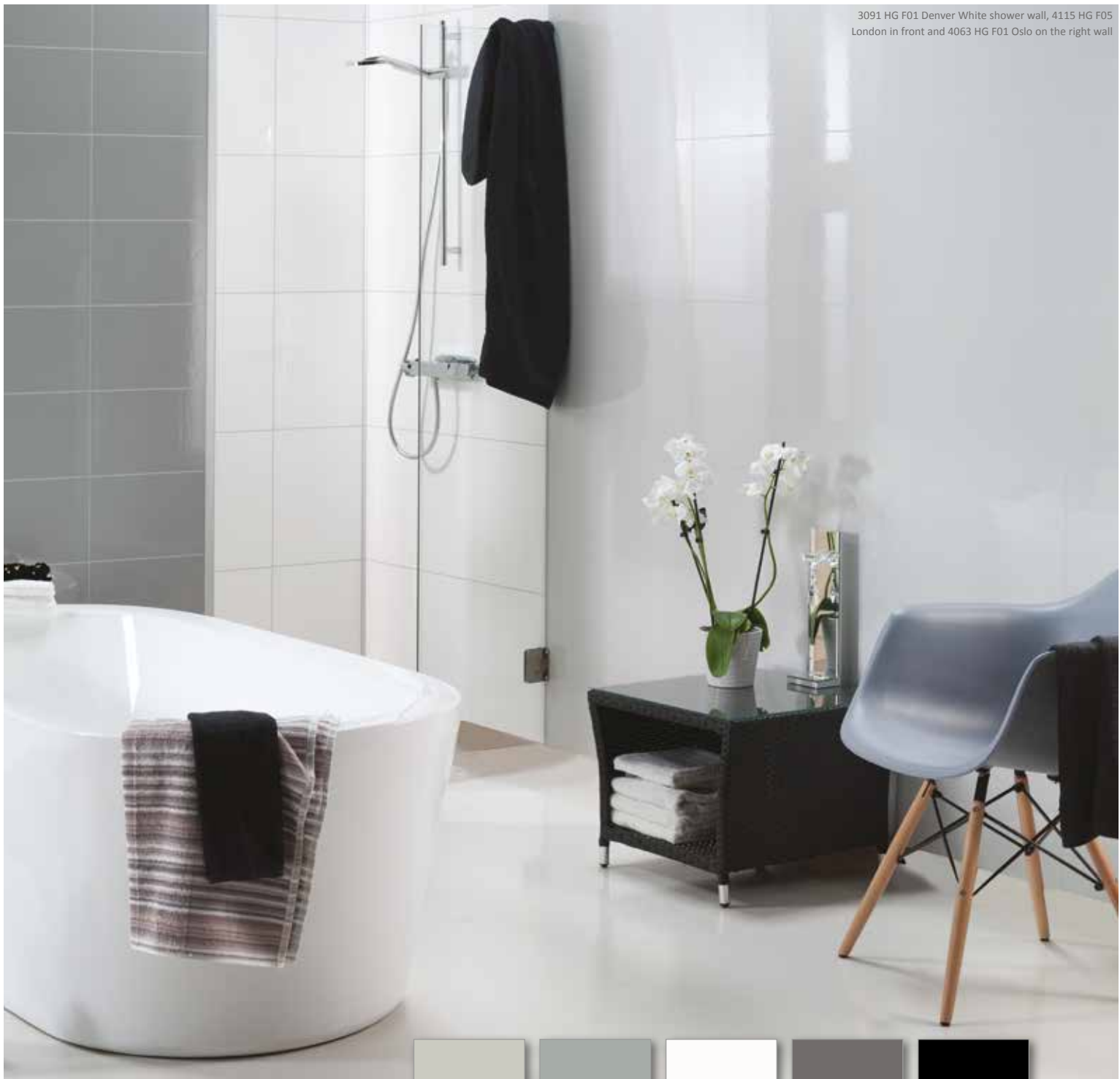

## GRAY MINIMALISM

Use the walls as a neutral canvas to accentuate furniture and other details in the room.

Grays was previously used by the great artists to highlight their talent instead of many and bright colors that easily hides errors in a painting.

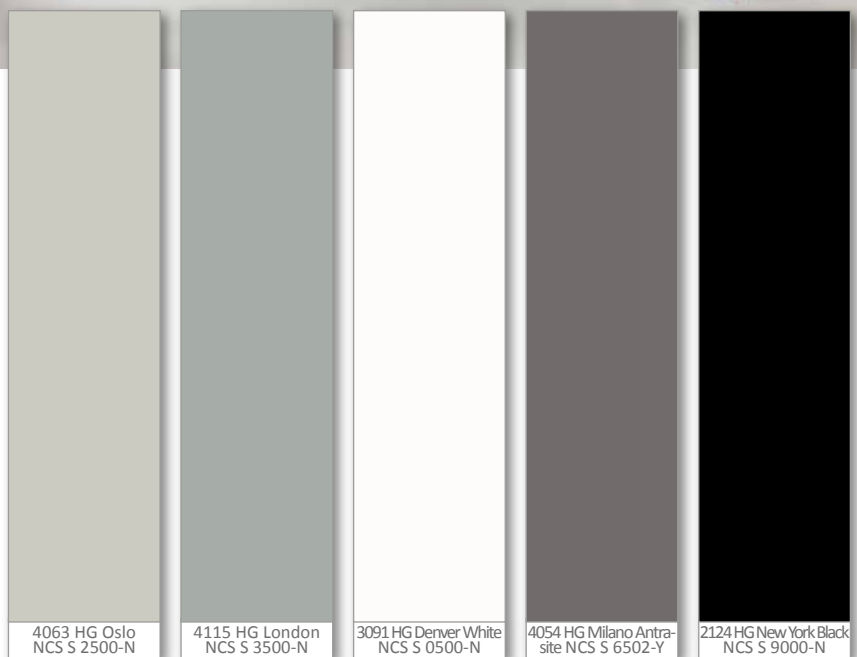

## EXTRA MATT SURFACE 1,8 MM JOINT WIDTH

With gorgeous extra matt surface, gives the room you peace and sense of wellbeing.

An entire collection- from morning to evening.

The whole new extra matt Color Collection comes with white grout- matching perfectly 1091 S Rhodes White which comes in a variety fresemønstere.

Welcome to our daily lives.

Colour Collection wallpanel with **1,8mm joint width** and groove colour **grey**, comes in extra matt finish.

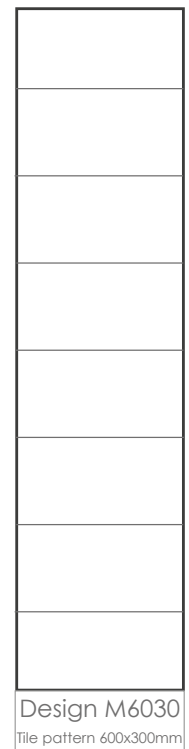
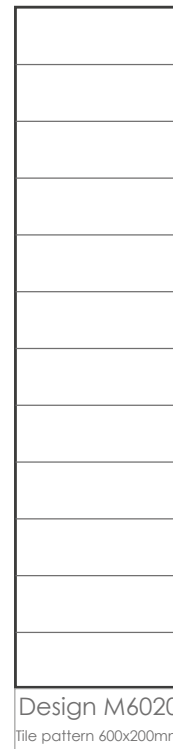
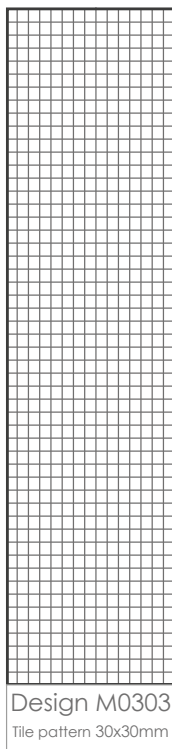
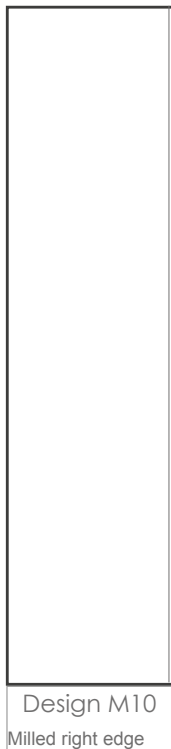

### All colour in Extra Matt surface.



Note: the colors may differ slightly from the actual product: EM = Extra matt.





0091 Cairo EM  
NCS S 1005 -Y10Y



2115 San Francisco EM  
NCS S 1005 -Y10Y



0091 EM Cairo and 0089 EM Aberdeen M0303 and M6040

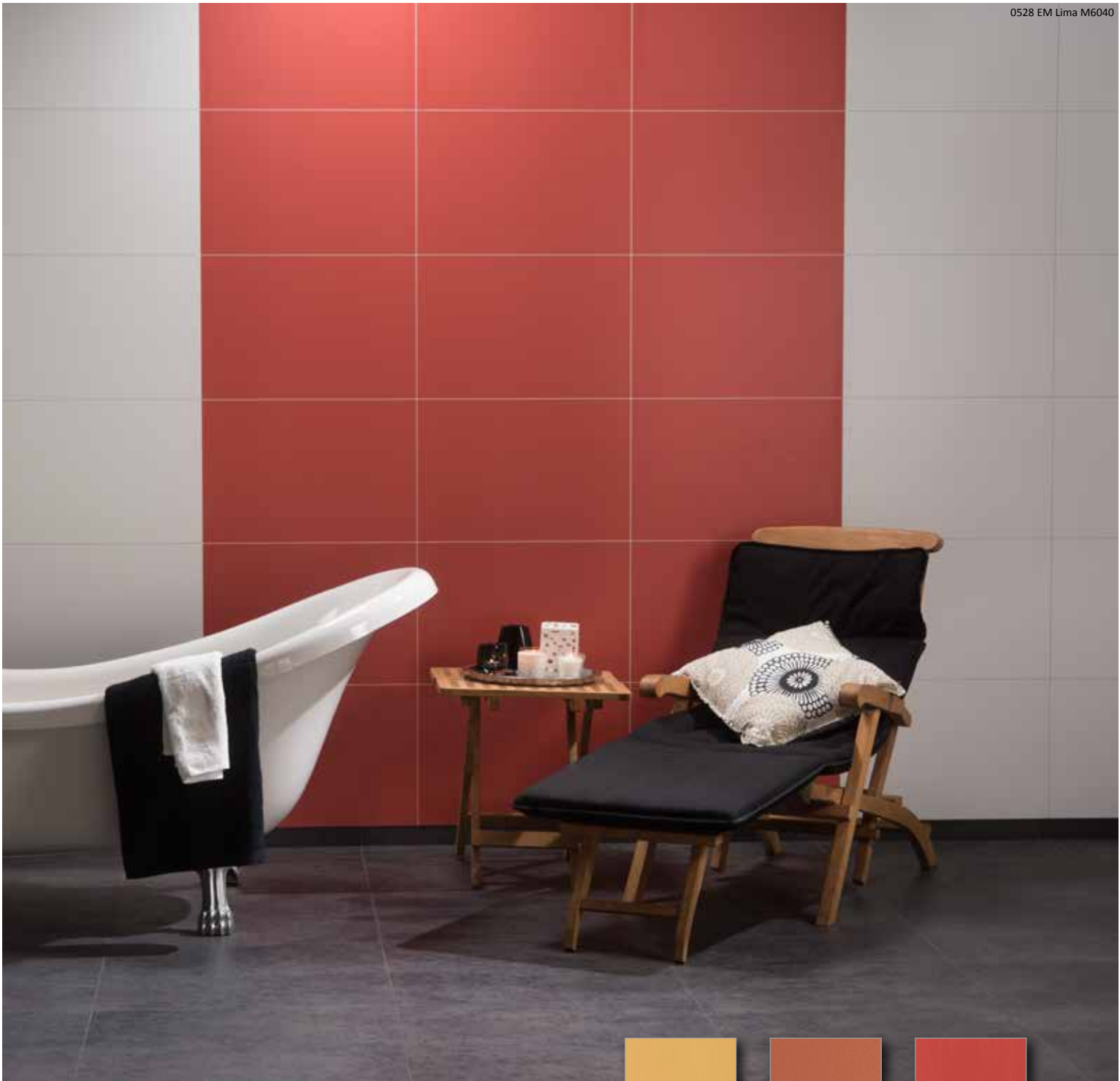

0092 EM Marrakech M6040



0092 Marrakech EM  
NCS S 1030-Y10R



0529 Havana EM  
NCS S 2030-Y60R



0528 Lima EM  
NCS S 2050-Y90R

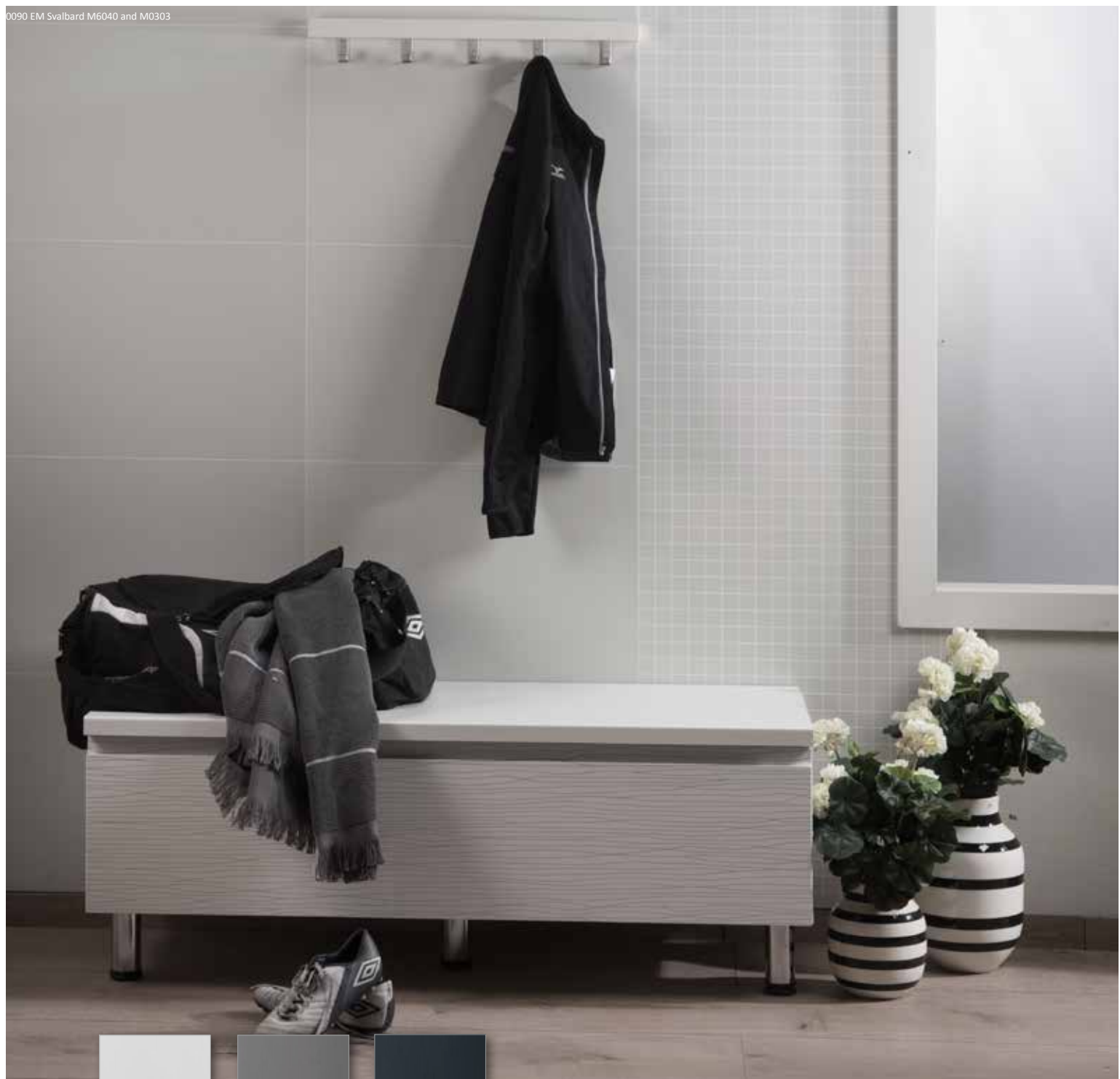

0090 Svalbard EM  
NCS S 1205-G50Y



0089 Aberdeen EM  
NCS S 4500-N



0433 Reykjavik EM  
NCS S 7005-B20G





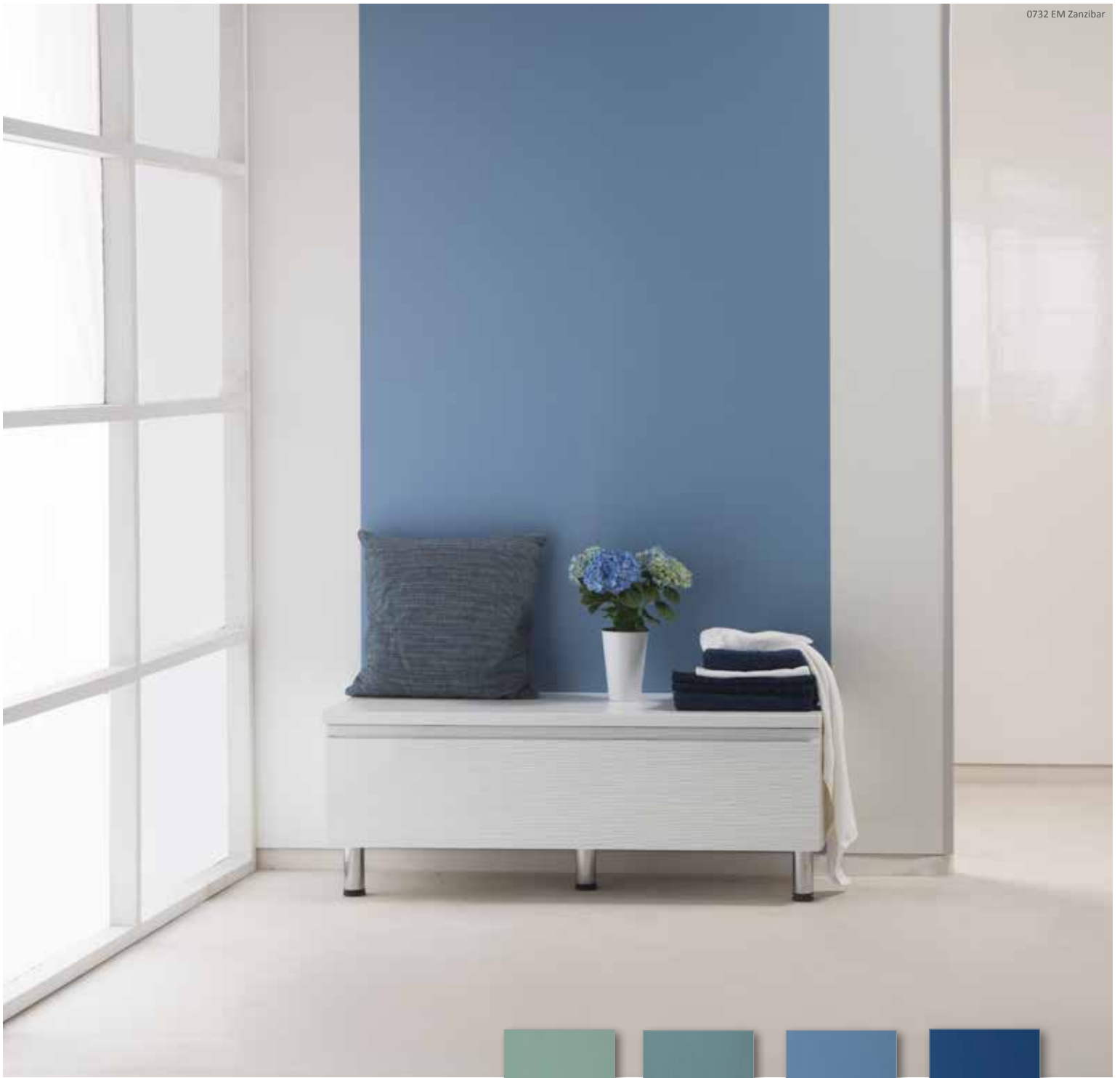

0530 EM Kingston M6020



0087 Hanoi EM  
NCS S 1515-G



0530 Kingston EM  
NCS S 3020-B50G



0732 Zanzibar EM  
NCS S 2030-R80B



0196 Santorini EM  
NCS S 5030-R80B





*..new gorgeous  
bathroom walls  
in a weekend*



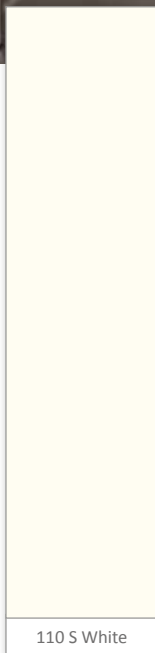
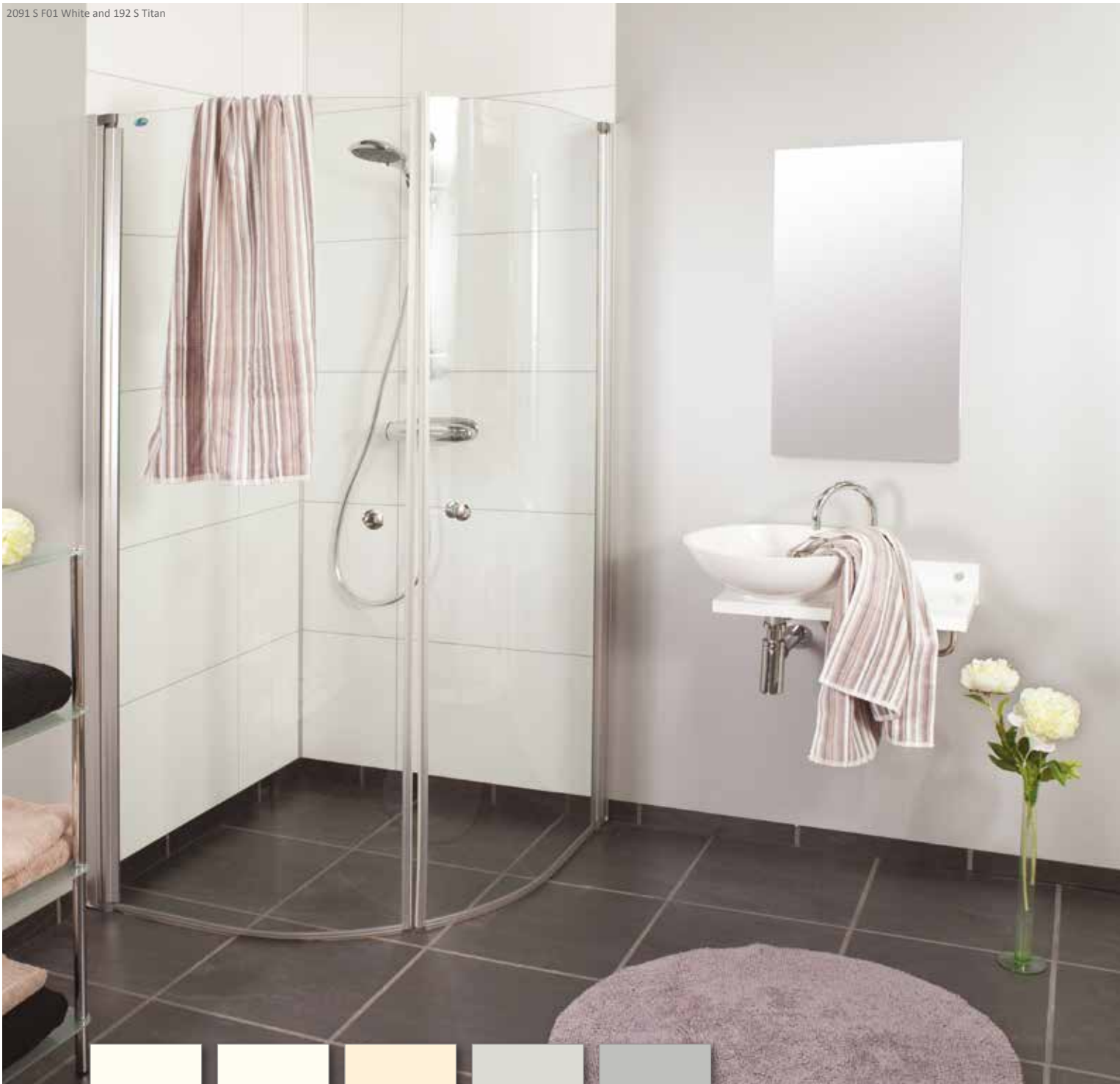

110 S White

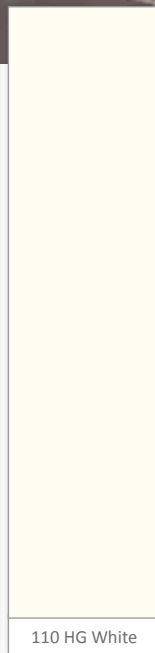

110 HG White

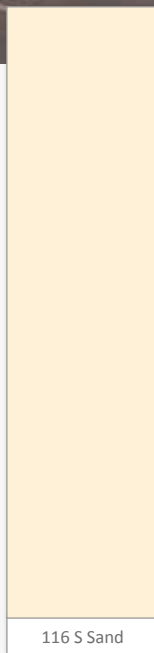

116 S Sand

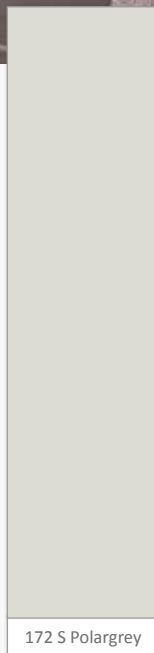

172 S Polargrey



192 S Titan

## LEGATO

Our classic and traditional collection is used with success in modern and minimalistic rooms.

The Legato collection has 5 decors, 4 plain colors and the 192 S Titan, which looks like a steel surface. All easy to clean and maintain.



505 G  
Gavot



506 HG  
Toscana marmor

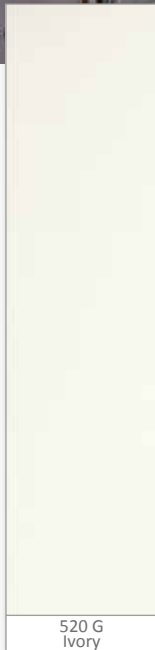

520 G  
Ivory



544 S  
Frostblue

## ADAGIO

A little more sophisticated, yet still delicate and soft- reflecting modern trends.

This quality product has been used in thousands of bathrooms and other wet rooms all over the Nordic countries for decades.

7969 SC M66 Rough Wood, 2091 S ME88 White and 4091 SL M63 White Slate



7969 SC M66 Rough Wood



2204 S M63 Cracked Cement



# FIBO-TRESPO AQUALOCK, ACCESSORIES AND PROFILES

## - for safe and easy installation!

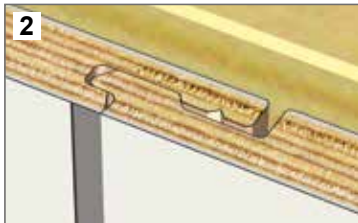

### AQUALOCK

Fibo-Trespo Wall panels are delivered with the Aqua Lock system. This makes the installation easy and gives a consistent and great result.

Design approval: D21569 No.00 + US.00  
 Patent approval: P24306 No.00 + US.00 + EP.00  
 Fire class D-s1.d0



**Cleaning and maintenance:**  
 Simply wipe with a damp cloth or a mild non-abrasive cream cleaner.  
 NB! Acetone or equivalent must not be used for removing stains, glue or sealant, either in panels or lists.



recommended product of FFV.



NBI approved



CE-market



Delivered with the Aqua Lock

### EPROPERTIES:



### ACCESSORIES:



Note: the colors may differ slightly from the actual product.  
 Abbreviations: HG = High Gloss, G = Gloss, S = Silk, SL = Slate, FW = Fresh Wood (rough surface)  
 EM = Extra Matt, RU = Rustic, SA = Spatolato, SC = Saw cut, C = Cement, P1 = Matt surface with high gloss pattern.

ETAG 022 Approved sealants:  
 Fibo Seal, Fugger Seal All, Soudaseal 215 LM, CT1, Optimera Bathroom Seal and Casco Aquaseal.

### PROFILE OPTIONS:

All profiles are 2400 mm

L-shaped finishing profile alu and PVC white, grey	Base profile alu	External corner alu	Internal corner alu and pvc	Internal Corner 135°* alu	External Corner 135°* alu	2-pcs internal corner 90° White and alu	2-pcs joining profile White and alu

Aluminium lists are delivered predrilled, grooved and individually plastic wrapped. \* profiles also delivered in 3000 mm

# MOUNTING

## NORWEGIAN REGULATIONS

with 2-piece internal corner profile or standard internal corner profile.  
Wallpanel with Aqualock.

In the wet zone, all profiles, cut surfaces, joints and drip noses, **MUST** be cleaned and have sealant applied. Fibo-Wipes is only to be used on laminate surfaces.

Fibo Seal is recommended as a sealant. It is approved by the norwegian building research institute (nbi) and in accordance with etag 022.



The panels can be mounted on existing walls or on a levelled timber frame with a centre to centre distance of 600 mm and horizontal battens at 800 mm centres. **NB!** When attaching heavy items such as washbasins, there must be additional studding. **NB!** Acclimatisation! The panels **MUST** be stored flat at room temperature for 3 days prior to being used (longer if they have been kept in cold storage).



Where there is a requirement/need for a solid wall behind the panel, a minimum 12 - 15 mm x 18 mm plywood or rough panels should be used. Using a solid wall is an ideal solution for the installation of our 300 mm effect panels.

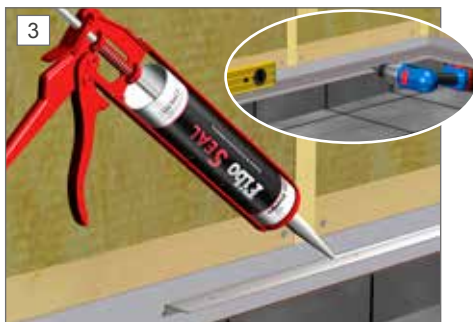

Mount the base profile about 60 - 80 mm from the floor, apply sealant to the lower back of the profile, and screw it to the wall. See also section 18. Applies to both installation with standard and 2-piece internal corner profile. Use a spirit level / laser to ensure that the profile is level.

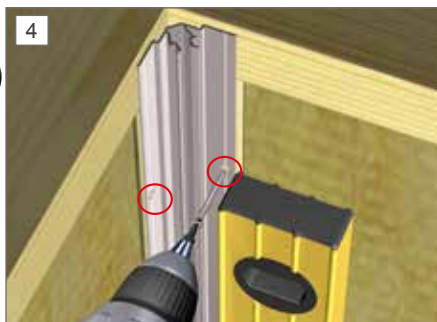

All installation must be performed from left to right. Reinforcement strip to be screwed in both drip grooves. For installation of wall base trim see section 2

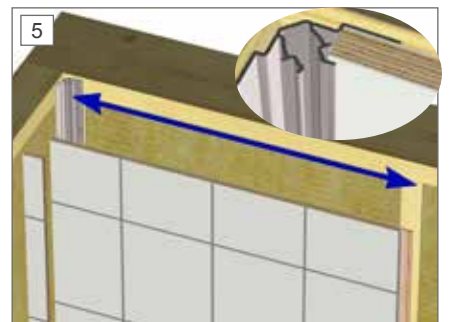

Measure the top and bottom of the first panel, (remember to measure into the profile and to the first studs). Cut the panel and test fit without sealant. **NB!** The panel **MUST** be plumb/ level. Clean cut surfaces, joint edge and under drip nose.



Apply approved sealant on the cut surfaces as shown in the drawing.

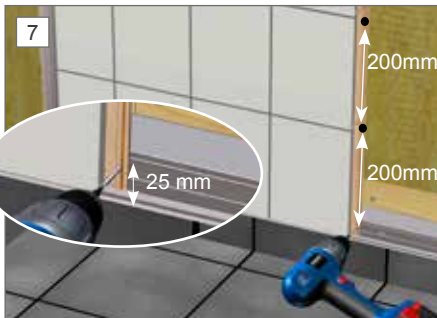

The panel is screwed to the stud as shown in the drawing.



Clean the joint edge and apply sealant on the joint edge and cut surface, prior to clicking it into place.



**NB** There should be so much sealant in the joint that the sealant oozes out along the length of the entire joint:  
1. Spray Fibo Clean on the excess sealant  
2. Remove with Fibo Fug  
3. Wipe away any visible sealant residue with Fibo Wipes

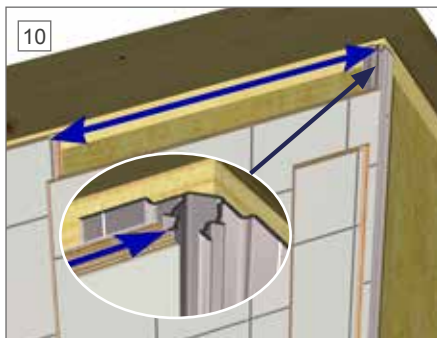

Take precise measurements, as shown in the drawing, but remove 1 - 2 mm. Test-fit without sealant.



Then fit the panel, by clicking it into place.



# MOUNTING

## NORWEGIAN REGULATIONS

with 2-piece internal corner profile or standard internal corner profile.  
Wallpanel with Aqualock.

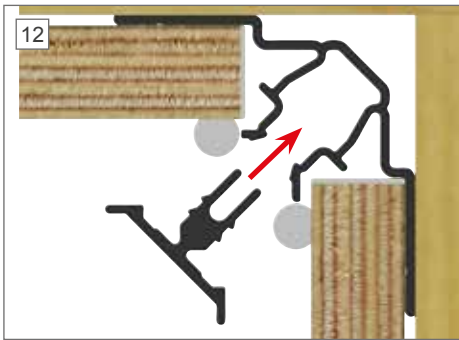

If there is a gap between the panel edge and inner section of the internal profile, this must also be filled with sealant. Apply an approximate 5 mm thick amount of Fibo Seal from the bottom to the top of the sheets on both sides about 4 - 5 mm out from the corner. 2nd cover part of the internal profile to be inserted from the bottom of the panel and slid into the 1st part inner profile. If needed use a tapping block, (tap carefully).

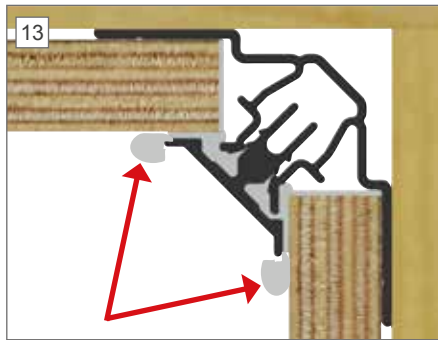

The sealant should ooze out along the entire length of the profile. Excess sealant can be removed with Fibo Clean and a sealing tool.



In order to be approved in accordance with Våtromsnormen (the Norwegian trade norm for wet rooms) an approved sealant must be used. Sealant to be applied as per drawing, see under.



For pipe penetrations, drill out a hole 5 mm larger in diameter than the pipe. Cut surfaces must be cleaned. Use approved pipe penetrations such as Uponor M6 or SanipeX.

### APPROVALS:



### APPROVALS:

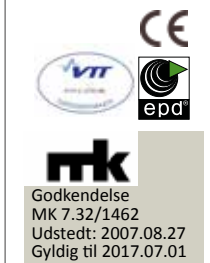

## Mounting with standard internal corner profile

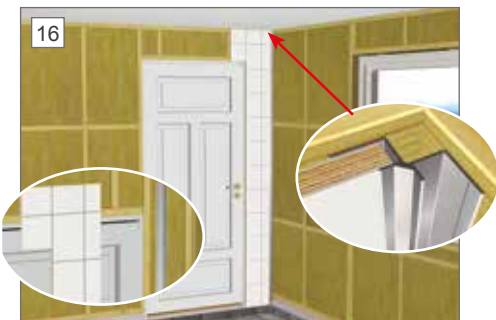

Start the installation as shown in the drawing. Adjust the length of the panels to meet the ceiling. Set the internal corner profile onto the panel, then fit both panel and corner profile into place, into the corner.  
**NB! The panels replace water vapour resistant foil on outer walls.**



The panels are fastened plumb at the top. Allow at least 5 mm distance up to ceiling. The inner corner profile is attached to the stud using screws through the pre-drilled holes. Remember to countersink the screws.

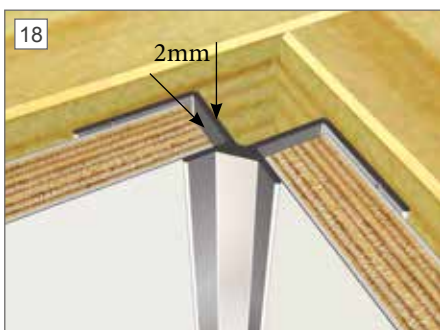

Make sure the next panel is plumb and adjusted to fit the next stud. Allow about 2 mm expansion in the inside corner moulding. In wet zones membrane should go up min. 45 mm behind the base profil/panel.



The final panel is folded at one side so that the joint will be neat and is fastened with staples, concealed by ceiling cornices and door architraves.

As the panels may have sharp edges, the use of gloves during assembly is recommended.  
As a filler/sealant we recommend Fibo seal.  
Fibo seal is approved by the norwegian building research institute (nbi) and in accordance with etag 022





2069 S F03 and F05 Zink, 2091 S F01 White

## INSPIRED?

We hope we have given you an idea of the amount of possibilities wall panels from Fibo-Trespo gives you.

Give yourself a great bathroom with atmosphere for relaxing and comfort, without compromising on quality.

The Fibo-Trespo wall panels provide instant water-proof, hygienic walls with a choice from a large range of colours and finishes.



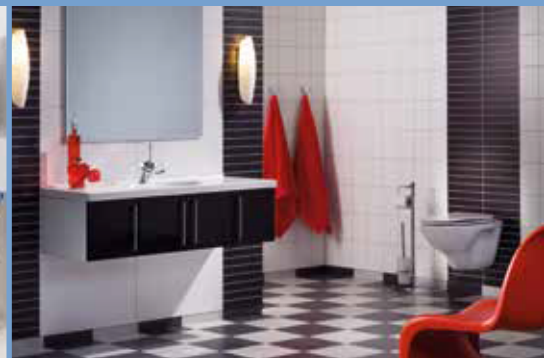

0316 - 200 stk. Tpkk: 50graf



# RISTRUTTURAZIONE A IMPATTO ZERO

Foto: Peder Austrup